



**Sentek**

# SINGLE MULTIPLE STATION PHOTOELECTRIC SMOKE DETECTOR SD-218 SERIES USER'S MANUAL

## TABLE OF CONTENTS

INTRODUCTION.....1  
 LOCATIONS TO INSTALL YOUR SMOKE DETECTOR .....1  
 LOCATIONS TO INSTALL YOUR SMOKE DETECTORS IN MOBILE HOMES AND RVs.....3  
 LOCATIONS NOT TO INSTALL YOUR SMOKE DETECTOR.....3  
 INSTALLING YOUR SMOKE DETECTOR .....4  
 HOW TO INTERCONNECT MODEL SD-218\*-I DETECTORS TOGETHER.....5  
 RED LED INDICATOR.....7  
 TESTING YOUR SMOKE DETECTOR.....7  
 TAKING CARE OF YOUR SMOKE DETECTOR .....7  
 HEAT SENSOR TESTING.....8  
 FIVE YEAR LIMITED WARRANTY .....8

## INTRODUCTION

SENTEK's single station photoelectric smoke detector is designed to sense smoke that comes into the detector chamber. It does not sense gas, heat, or flame. This smoke detector is designed to give early warning of developing fires by giving off the alarm sounds from its built-in alarm horn. It can provide precious time for you and your family to escape before a fire spreads. However, the smoke detector makes such pre-warning of fire accident possible, only if the detector is located, installed, and maintained properly as described in this User's Manual.

**WARNING:** This smoke detector is designed for use in a single residential unit only, which means that it should be used inside a single family home or apartment. It is not meant to be used in lobbies, hallways, basements, or another apartment in multi-family buildings, unless there are already working detectors in each family unit. Smoke detectors, placed in common areas outside of the individual living unit, such as on porches or in hallways, may not provide early warning to residents. In multi-family buildings, each family living unit should set up its own detectors.

**WARNING:** This detector is not meant to be used in non-residential buildings. Warehouses, industrial or commercial buildings, and special purpose non-residential buildings require special fire detection and alarm systems. This detector alone is not a suitable substitute for complete fire detection systems for places where many people live or work, such as hotels or motels. The same is true of dormitories, hospitals, nursing homes or group homes of any kind, even if they were once single family homes. Please refer NFPA 101, the Life Safety Code, NFPA71, 72A, 72B, 72C, 72D, and 72E for smoke detector requirements for fire protection in buildings not defined as "households".

## LOCATIONS TO INSTALL YOUR SMOKE DETECTOR

Smoke detectors should be installed in accordance with the NFPA Standard 74 (National Fire Protection Association, Batterymarch Park, Quincy, MA 02169). For complete coverage in residential units, smoke detectors should be installed in all rooms, halls, storage areas, basements, and attics in each family living unit. Minimum coverage is one detector on each floor and one in each sleeping area. and attics in each family living unit. Minimum coverage is one detector on each floor and one in each sleeping area.

Here, we have useful tips for you:

- Install a smoke detector in the hallway outside every separate bedroom area, as shown in Figure 1. Two detectors are required in homes with two bedroom areas, as shown in Figure 2.
- Install a smoke detector on every floor of a multi-floor home or apartment, as shown in Figure 3.

- Install a minimum of two detectors in any household.
- Install a smoke detector inside every bedroom.
- Install smoke detectors at both ends of a bedroom hallway if the hallway is more than 40 feet (12 meters) long.
- Install a smoke detector inside every room where one sleeps with the door partly or completely closed, since smoke could be blocked by the closed door and a hallway alarm may not wake up the sleeper if the door is closed.

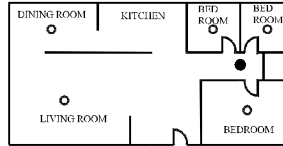

Figure 1: LOCATIONS FOR PLACING SMOKE DETECTORS FOR SINGLE RESIDENCE WITH ONLY ONE SLEEPING AREA

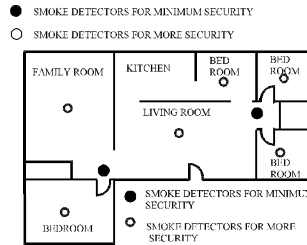

Figure 2: LOCATIONS FOR PLACING SMOKE DETECTORS FOR SINGLE-FLOOR RESIDENCE WITH MORE THAN ONE SLEEPING AREA

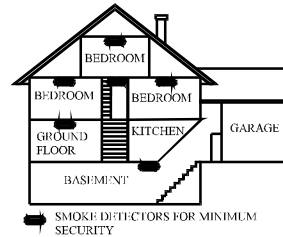

Figure 3: LOCATION FOR PLACING SMOKE DETECTORS FOR A MULTI-FLOOR RESIDENCE

- Install basement detectors at the bottom of the basement stairwell.
- Install second-floor detectors at the top of the first-to-second floor stairwell.

Be sure no door or other obstruction blocks the path of smoke to the detector.

- Install additional detectors in your living room, dining room, family room, attic, utility and storage rooms.
- Install smoke detectors as close to the center of the ceiling as possible. If this is not practical, put the detector on the ceiling, no closer than 4 inches (10 cm) from any wall or corner, as shown in Figure 4.
- If ceiling mounting is not possible and wall mounting is permitted by your local and state codes, put wall-mounted detectors between 4 and 6 inches (10 ~ 15 cm) from the ceiling, also see Figure 4.
- If some of your rooms have sloped, peaked, or gabled ceilings, try to mount detectors 3 feet (0.9 meter) measured horizontally from the highest point of the ceiling as shown in Figure 5.

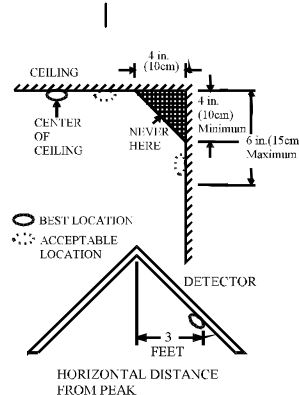

Figure 4: RECOMMENDED BEST AND ACCEPTABLE LOCATIONS TO MOUNT SMOKE DETECTORS

Figure 5: RECOMMENDED LOCATION TO MOUNT SMOKE DETECTORS IN ROOMS WITH SLOPED, GABLED, OR PEAKED CEILING

△ **CAUTION** (As required by State Fire Marshall)

"Early warning fire detection is best achieved by the installation of fire detection equipment in all rooms and areas of the household as follows: (1) A

- Install a smoke detector on every floor of a multi-floor home or apartment, as shown in Figure 3.

smoke detector installed in each separate sleeping area (in the vicinity, but outside of the bedrooms), and (2) Heat or smoke detectors in the living rooms, dining rooms, bedrooms, kitchens, hallways, attics, furnace rooms, closets, utility and, storage rooms, basements and attached garages.”

For your information, NFPA Standard 74, Section 2-4 reads as follows:

“2-4.1.1 Smoke detectors shall be installed outside of each separate sleeping area in the immediate vicinity of the bedrooms and on each additional story of the family living unit including basements and excluding crawl spaces and unfinished attics.

The provisions of 2-4.1.1 represent the minimum number of detectors required by this standard. It is recommended that the householder consider the use of additional smoke detectors for increased protection for those areas separated by a door from the areas protected by the required smoke detectors under 2-4.1.1 above. The recommended additional areas are living room, dining room, bedroom(s), kitchen, attic (finished or unfinished), furnace rooms, utility room, basement, integral or attached garage, and hallways not included in 2-4.1.1 above. However, the use of additional detectors remains the option of the householder.” We recommend complete coverage and use of additional smoke detectors.

## LOCATIONS TO INSTALL YOUR SMOKE DETECTORS IN MOBILE HOMES AND RVs

Mobile homes and RVs built after about 1978 were designed and insulated to be energy-efficient. In mobile homes and RVs built after 1978, smoke detectors should be installed as described above. Older mobile homes and RVs may have little or no insulation compared to current standards. Outside walls and roofs are often made of non-insulated metal, which can transfer thermal energy flow from outdoors. This makes the air right next to them hotter or colder than the rest of the inside air. These layers of hotter or colder air can keep smoke from reaching a smoke detector. Thereby, install smoke detectors in such units only on inside walls. Place them between 4 and 6 inches (10 ~ 15 cm) from the ceiling. If you are not sure how much insulation is in your mobile home or RV, then install the detector on an inside wall. If the walls or ceiling are unusually hot or cold, then install the detector on an inside wall. Install one detector as close to the sleeping area as possible for minimum security, or install one detector in each room for security. Before you install any detector, please read the following section on “LOCATIONS NOT TO INSTALL YOUR SMOKE DETECTORS”.

## LOCATIONS NOT TO INSTALL YOUR SMOKE DETECTORS

Nuisance alarms take place when smoke detectors are installed where they will not work properly. To avoid nuisance alarms, do not install smoke detectors in the following situations:

- Combustion particles are the by-products of something that is burning. Thus, in or near areas where combustion particles are present you do not install the smoke detectors to avoid nuisance alarms, such as kitchens with few windows or poor ventilation, garages where there may be vehicle exhaust, near furnaces, hot water heaters, and space heaters.
- Do not install smoke detectors less than 20 feet (6 meters) away from places where combustion particles are normally present, like kitchens. If a 20-foot distance is not possible, e.g. in a mobile home, try to install the detector as far away from the combustion particles as possible, preferably on the wall. To prevent nuisance alarm alarms, provide good ventilation in such places.

**IMPORTANT:** For any reason, do not disable the detector to avoid nuisance alarms.

- When air streams passing by kitchens, the way how a detector can sense combustion particles in normal air-flow paths is graphically shown in Figure 6, which indicates the correct and incorrect smoke detector locations concerning this problem.

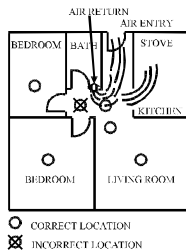

Figure 6: RECOMMENDED SMOKE DETECTOR LOCATIONS TO AVOID AIR STREAMS WITH COMBUSTION PARTICLES

3

- In damp or very humid areas, or near bathrooms with showers. Moisture in humid air can enter the sensing chamber, then turns into droplets upon cooling, which can cause nuisance alarms. Install smoke detectors at least 10 feet (3 meters) away from bathrooms.

- In very cold or very hot areas, including unheated buildings or outdoor rooms. If the temperature goes above or below the operating range of smoke detector, it will not work properly. The temperature range for your smoke detector is 32 °F to 120 °F (0 °C to 50 °C).
- In very dusty or dirty areas, dirt and dust can build up on the detector’s sensing chamber, to make it overly sensitive. Additionally, dust or dirt can block openings to the sensing chamber and keep the detector from sensing smoke.
- Near fresh air vents or very drafty areas like air conditioners, heaters or fans, fresh air vents and drafts can drive smoke away from smoke detectors.
- Dead air spaces are often at the top of a peaked roof, or in the corners between ceilings and walls. Dead air may prevent smoke from reaching a detector. See Figures 4 and 5 for recommended mounting locations.
- In insect-infested areas. If insects enter a detector’s sensing chamber, they may cause a nuisance alarm. Where bugs are a problem, get rid of them before putting up a detector.
- Near fluorescent lights, electrical “noise” from fluorescent lights may cause nuisance alarms. Install smoke detectors at least 5 feet (1.5 meters) from such lights.

**WARNING:** Never remove batteries to stop a nuisance alarm. Open a window or fan the air around the detector to get rid of the smoke. The alarm will turn itself off when the smoke is gone. If nuisance alarms persist, attempt to clean the detector as described in this User’s Manual.

**WARNING:** Do not stand close to the detector when the alarm is sounding. The alarm is loud in order to wake you in an emergency. Too much exposure to the horn at close range may be harmful to your hearing.

## INSTALLING YOUR SMOKE DETECTOR

Model SD-218 series smoke detectors are to be mounted on the ceiling or on the wall if necessary. Since SD-218 series smoke detector is a single-station type, it cannot be linked to other detectors. Model SD-218 series with I mark can serve as a single-station, stand-alone unit, or can be interconnected with other SD-218 series with I mark detectors. (See “HOW TO CONNECT SD-218\*-I DETECTORS TOGETHER.”)

**WARNING:** Do not connect the SD-218 series smoke detectors to any other alarm or auxiliary device. Connecting anything else to this detector will keep it from working properly.

Read “LOCATIONS TO INSTALL YOUR SMOKE DETECTORS” and “LOCATIONS NOT TO INSTALL YOUR SMOKE DETECTORS” section in this Manual first, then decide where to install a detector.

**IMPORTANT: For the AC powered model- To avoid the electrical shock hazard, turn off power to the area where you plan to install the detector at the fuse box or circuit breaker box**

Please follow these steps to install your smoke detector:

1. At the place where you are going to install the detector, draw a horizontal line six inches long.
2. Remove the mounting bracket from your unit by rotating it counterclockwise.
3. Place the bracket so that the two longest hole slots are aligned on the line. In each of keyhole slots, draw a mark to locate a mounting plug and screw.
4. Remove the bracket.
5. Using a 3/16-inch (5mm) drill bit, drills two holes at the marks and insert plastic wall plugs. Put the detector away from getting plaster dust on it when you drill holes for mounting.
6. Using the two screws and plastic wall plugs (all supplied), attach the bracket to the wall.

**NOTE:** If this detector is to be connected to other detectors, read the instructions in the Section of “How to Interconnected Model with -I Series Detector Together” before you finish installing the detector. If the detector is not for interconnection purpose, do not use the “INTERCONNCT” wire.

**For AC powered model, please read the message as following:**

A power connector with **brown**, **orange (for interconnection model)**, and **blue** wires is packed with each detector. Use wire nuts to connect these wires to the AC power supply. Connect the **brown** wire on the connector to the **brown** AC power supply. Connect the **blue** wire on the connector to the **blue** AC wire. While the **orange** wire is used for INTERCONNCT mode only. And the **red** wire is used for 9Vdc output only.

4

Plug the power connector into other connector attached at the back of the detector as shown in Figure 7. It is keyed so it can only be installed one way. Tug the connector to be sure that it is plugged in correctly. The connector can be removed at any time by holding the connector body firmly and pulling it out.

**WARNING: Do not connect AC power wires to the**

**“INTERCONNECT” (orange) wire.** If doing so, it will damage the detector.

- Line up the slot of the bracket and the detector. Push the detector onto the mounting bracket and turn it clockwise to fix it into place. Pull outward on the detector to make sure it is securely attached to the mounting bracket.

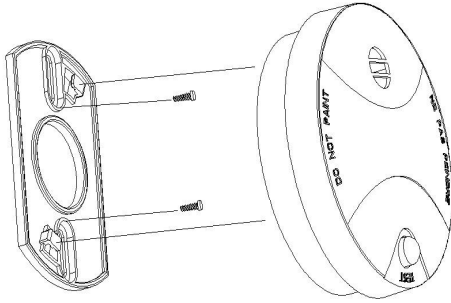

- The steps to open the battery cover and to install the battery are listed as follows:

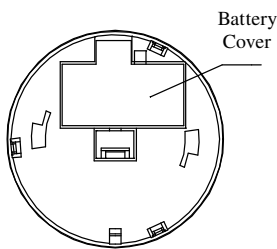

- To power Smoke detector requires an alkaline battery.
- Match terminals on the end(s) of the battery with opposite terminal connections on the detector. Be sure to insert the alkaline battery in the position shown on the detector.
- When terminals are properly matched, push battery firmly in until it snaps and cannot be shaken loose.

**IMPORTANT: For the AC powered model- Whenever placing or removing battery in the detector, try to disconnect AC power at the fuse box or circuit breaker to avoid electrical shock hazard.**

**CAUTION:** This smoke detector comes with cover latches that will prevent the smoke detector cover from closing if battery is not installed. This tells you that the smoke detector will not work until a new battery is properly installed. **The battery is purposely positioned WRONGLY in the factory to keep it fresh until installation. It must be re-positioned correctly to provide DC power.**

**NOTE:** When the detector battery first makes contact with the detector, the alarm horn may sound for one second. This means normal and indicates that the battery is positioned properly. Close cover, then press the test button, holding it down for about 5 seconds until the horn sounds. The horn should sound a loud, pulsating alarm. This means the unit is working properly.

## HOW TO INTERCONNECT MODEL SD-218\*-I DETECTORS TOGETHER

**Warning:** Failure to follow the installation instructions below could result in malfunction and damage to the detector.

The SD-218 series with I mark smoke detectors means with "interconnection" capability may be connected together. Then, if one detector senses smoke, all of them will sound their alarms. The following conditions must be met to ensure the interconnected detectors working properly:

- The SD-218 series with I mark smoke detector can be interconnected only to other detectors of the same type. **DO NOT** connect to any other type or model smoke alarm.
- The SD-218 series with I mark smoke detectors may be interconnected with as many as 38 other detectors.
- The total length of wire interconnecting the detectors should be no more than 1000 feet. The interconnecting wire should be #18 AWG or larger and be rated at least 300V.
- The installation of such detector must be in accordance with the requirements of Article 760 of the National Electrical Code and any local

codes that apply.

- Wire the interconnection type detectors by connecting the interconnect connectors on all units together. See figure 9.
- Be sure the batteries are properly installed for each detector.
- To test the system, push test button on each detector. The alarm horns on all of the detectors in the system should sound if they are interconnected correctly. Make sure that all other units in the system sound an alarm as each unit is tested. Interconnect the detectors within one family residence area only. Otherwise,

when a detector in another residence is tested, the occurrence of nuisance alarms may take place.

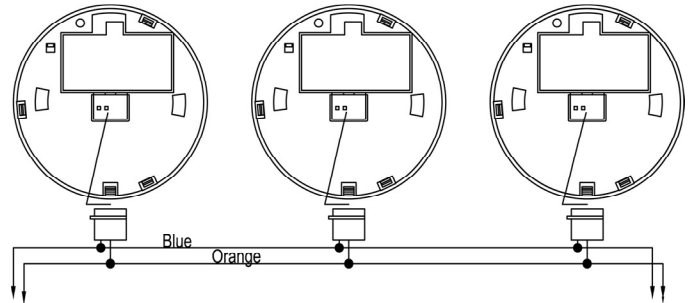

- NOTES FOR INTERCONNECTION:
- Blue to Ground
  - Orange to Interconnection

TO ADDITIONAL DETECTORS  
MAX. OF 38 INTERCONNECTED

Figure 9.A: WIRING DIAGRAM FOR INTERCONNECTION MODEL SD-218 series with I mark

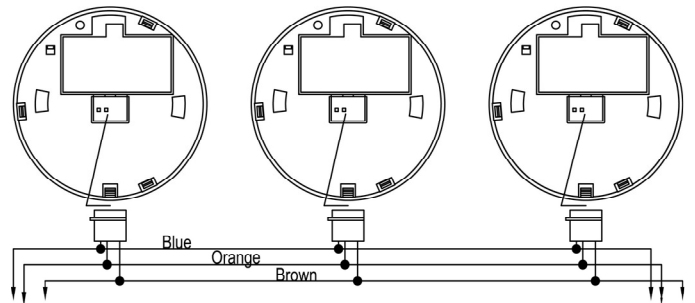

- NOTES FOR INTERCONNECTION:
- Brown to Hot (Live)
  - Blue to Neutral
  - Orange to Interconnection

TO ADDITIONAL DETECTORS  
MAX. OF 38 INTERCONNECTED

Figure 9.B: WIRING DIAGRAM FOR INTERCONNECTION MODEL SD-218-A series with I mark

**NOTES FOR NON-INTERCONNECTION AC MODELS, THERE'S NO "ORANGE" WIRE, PLEASE CONNECT ONLY BLUE AND BROWN WIRES.**

- Brown to Hot (Live)
- Blue to Neutral

## RED INDICATOR

The red LED, as the ALARM indicator, is featured with the detector. It can be seen through the test button on the cover of the detector. When red LED flashes once 32 seconds, it indicates the detector under normal operation. When smoke detector senses smoke and simultaneously sounds an audible alarm, the red LED will flash very frequently, once 0.67 seconds. For the interconnected system, whereas the red LED does not light, it indicates that the other detector(s) belonging to the same interconnection system has sensed smoke and is signaling the alarm.

## TESTING YOUR SMOKE DETECTOR

Test the detector weekly by pushing firmly on the test button with your finger until the horn sounds. Testing method may take up to 20 seconds to sound the alarm horn. These are only ways to be sure that detector is working correctly. If the detector fails to test properly, have it repaired or replaced

immediately.

**NOTE:** For interconnection model SD-218 series with I mark detectors: When an interconnection system of model SD-218 detectors goes into alarm, the indicator LED on the only detector(s) sensing smoke will flash for every 0.67 second, while the indicator LED on the rest of detectors will not flash.

**WARNING:** Never use an open flame to test your detector. You may set fire to damage the detector, as well as your home. The built-in test switch accurately tests all detector functions, as required by Underwriters' Laboratories. They are the only correct ways to test the unit.

**WARNING:** When you are not testing the unit and the alarm horn sounds a loud continuous sound, this means the detector has sensed smoke or combustion particles in the air. Be sure that the alarm horn is a warning of a possible serious situation, which requires your immediate attention.

- The alarm could be caused by a nuisance situation. Cooking smoke or a dusty furnace, sometimes called "friendly fires" can cause the alarm to sound. If this happens, open a window or fan the air to remove the smoke or dust. The alarm will turn off as soon as the air is completely clear.

**NOTE:** Do not disconnect the battery from the detector. This will remove your protection from fires.

- If the alarm horn begins to beep once a minute, this signal means that the detector's battery is weak. Replace new battery immediately. Keep fresh batteries on hand for this purpose.

### TAKING CARE OF YOUR SMOKE DETECTOR

To keep your detector in good working order, you must test the detector weekly, as referring to section "TESTING YOUR SMOKE DETECTOR".

- Replace the detector battery once a year or immediately when the low battery "beep" signal sounds once 32seconds at same time the LED flash. The low battery "beep" should last at least 30 days.

**NOTE:** For replacement battery, use Golden Power G6F22, G6F22M, GL6F22A, Eveready #522, #1222, #216; Duracell #MN1604; or Gold Peak #1604P, #1604S, #1604A; or Ultralife U9VL-J.

**WARNING:** Do not use any other kind of battery. This detector may not operate properly with other kind of battery.

- Normal, the LED flashes every 32 seconds. A beep or chirp occurring at half time of LED flashes, it indicates the detector is fault.
  - Open the cover and vacuum the dust off the detector's sensing chamber at least once a year. This can be done when you open the detector to change the battery. Remove battery before cleaning. To clean detector, use soft brush attachment to your vacuum. Carefully remove any dust on detector components, especially on the openings of the sensing chamber. Replace battery after cleaning. Test detector to make sure battery is incorrectly. Check to make sure there are no obstruction inside the test button. If there is any dust in the test button, insert a toothpick from the back to the front.
- NOTE:** If nuisance alarms keep coming from the detector, you should check whether the detector's location is adequate. Refer to section "WHERE TO INSTALL SMOKE DETECTORS." Move your detector if it is not located properly. Clean detector as described above.

- Clean detector cover when it gets dirty. First open the cover and remove battery. Hand-wash cover with cloth dampened with clean water. Dry it with lint-free cloth. Do not get any water on the detector components. Replace the battery, and close cover. Test detector to make sure that battery works correctly.

### HEAT SENSOR TESTING

**NOTE:** For SD218 series detectors that without HEAT DETECTION, please skip the description of this section).

The detector to be tested should be subject to a flow of warm air at a temperature between 132°F and 180 °F. This requirement can be met by some domestic hair dryers.

Proceed as follows:

1. Switch on the warm air flow and check that temperature is correct and stable.

7

2. From a distance of inches, direct the airflow at the guard protecting the thermistor. The detector should alarm within 30 seconds.
3. On alarm immediately remove the heat source, check that the detector's red LED is lit. Reset the detector from the control panel.
4. If the detector fails to go into alarm within 30 seconds it is too insensitive and needs to be returned to the distributor for servicing.

5. After testing check that the system is set for normal operation and notify the appropriate authorities that the testing operation is complete and the system is active again.

### FIVE YEAR LIMITED WARRANTY

**NOTE:** In order to protect your right, please keep the original purchase receipt for the proof of buying SENTEK detector from our authorized dealers. No warranty can be offered without the original purchase receipt.

SENTEK warrants its enclosed Smoke Detector - but not the battery - to be free from defects in materials and workmanship under normal use and service for a period of five years from date of purchase. SENTEK makes no other express warranty for this smoke detector. No agent, representative, dealer, or employee of the Company has the authority to increase or alter the obligations or limitations of this Warranty. The Company's obligation of this Warranty shall be limited to the repair or replacement of any part of the detector which is found to be defective in materials or workmanship under normal use and service during the five year period commencing with the date of purchase.

During the initial one-year period commencing with the date of purchase, such repair or replacement shall be made without charge. During the latter four years of the Warranty period, such repair or replacement shall be made at a charge to the Customer not to exceed the manufacturer's cost. Units in need of repair should be returned, shipping prepaid, to Customer Service Department, Ningbo Sentek Electronics Co., Ltd. -448 Yingchun Road, Wangchun Industrial Zpone, Ningbo City 315175, Zhejiang, China.

The Company shall not be obligated to repair or replace units, which are found to be in need of repair because of damage, unreasonable use, modifications, or alterations occurring after the date of purchase. The duration of any implied Warranty, including that of merchantability or fitness for any particular purpose, shall be limited to the period of five years commencing with the date of purchase. In no case shall the Company be liable for any consequential or incidental damages for breach of this or any other Warranty expressed or implied whatsoever, even if the loss or damage is caused by the Company's negligence or fault. Some states do not allow the exclusion or limitation of incidental or consequential damages, so the above limitation or exclusion may not apply to you. SENTEK makes no warranty, expressed or implied, written or oral, including that of merchantability or fitness for any particular purpose, with respect to the batteries. This Warranty gives you specific legal rights, and you may also have other rights which vary from state to state.

### SENSOR SPECIFICATION :

Smoke Sensitivity:	0.08~0.15dB/m (EN standard) 0.98~2.60%/ft (UL standard)
Temperature Sensitivity	135° F (57° C) for with Heat sensor model only
Standby Current:	8µA
Alarm Current:	15mA
Temperature Range	0°C to 50°C
Humidity:	0 to 95% RH, no condensation or icing
Alarm Sound Level	85 db/3m

ISSUE NO. SD-218 REV.B

Ningbo Sentek Electronics Co., Ltd. - 488. Yingchun Road, Wangchun Industrial Zone, Ningbo City 315175, Zhejiang, China.

[www.sentek.cc](http://www.sentek.cc); [www.chinabestkey.com](http://www.chinabestkey.com)

MADE IN CHINA