



Inquiry Onsite Environment  
with a FREE Call or SMS!

High-Low Threshold alarm  
with SMS text Message alert!

Interval Report Environment  
to Your Mobile Phone by SMS!

# GSM 3G Environment Alarm Temperature & Humidity & Power Status



## Temperature GSM Humidity Alarm Power Status

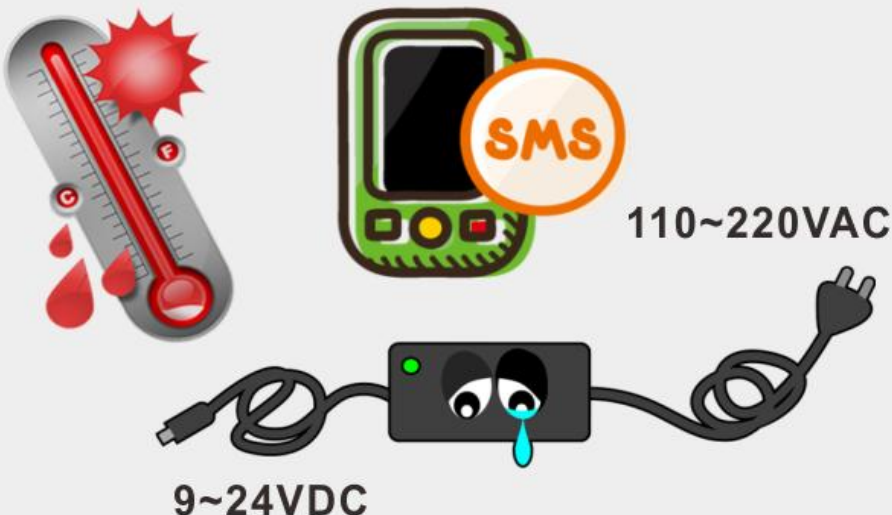

### User Manual

Ver 1.0

RTU5023

Date Issued: 2016-11-24

All rights reserved by King

Pigeon Hi-Tech. Co., Ltd.

[www.GPRS-M2M.com](http://www.GPRS-M2M.com)



# GSM 3G Environment Alarm Temperature&Humidity&Power Status

## Table of contents

1.	Brief introduction -----	3
2.	Safety Directions -----	3
3.	Standard Packing list -----	3
4.	Mainly Features -----	3
5.	Physical Layout and Installation Diagram-----	4
6.	Initialize/Reset the GSM unit -----	6
7.	Settings & Operations-----	7
8.	Technical specifications -----	10
9.	Warranty -----	10

This handbook has been designed as a guide to the installation and operation of RTU5023 GSM 3G Environment Alarm.

Statements contained in the handbook are general guidelines only and in no way are designed to supersede the instructions contained with other products.

We recommend that the advice of a registered electrician be sought before any Installation work commences.

King Pigeon Hi-Tech.Co., Ltd, its employees and distributors, accept no liability for any loss or damage including consequential damage due to reliance on any material contained in this handbook.

King Pigeon Hi-Tech.Co., Ltd, its employees and distributors, accept no liability for GSM Network upgrading or SIMCard upgrading due to the technology specifications contained in this handbook.

**\*\*\*Strongly recommend you use the APP to program it\*\*\***





# GSM 3G Environment Alarm Temperature&Humidity&Power Status

## 1. Brief introduction

The GSM SMS 3G Environment Alarm is special for remotely monitoring onsite temperature, humidity, power status through wireless GSM/3G Network. When the temperature, humidity, power voltage exceed high threshold or low threshold value, will send SMS alert to upto 10 preset mobile phone immediately.

Just dial from Authorized User number, the GSM 3G Environment Alarm will reject at the first "Ring", no communication cost, and then return the current temperature, humidity, power status or voltage. Moreover, it can report onsite environment interval or daily.

The GSM 3G Environment Alarm can be used for solar power monitoring, DC power voltage monitoring, temperature monitoring, humidity monitoring, Class Room, Public Room, Waiting Room, Hospital, Stations, Fresh Food Warehouse, Office, Meeting Room, Laboratory, Library and anywhere that need monitoring temperature or control temperature in expected range.

## 2. Safety Directions



### Safe Startup

Do not use GSM unit when using GSM equipment is prohibited or might bring disturbance or danger.



### Interference

All wireless equipment might interfere network signals of GSM unit and influence its performance.

## 3. Standard Packing List

GSM 3G Environment Alarm X 1; Antenna X 1; AC/DC adaptor(12V1A) X1 ;User Manual X 1.

*Note: The package does not include any SIM card.*

**Optional:** AM2301 Temperature &Humidity Sensor, cable length 1m;  
AM2305 Temperature &Humidity Sensor, cable length 5m;  
AM2320 Temperature &Humidity Sensor, cable length 20m.

## 4. Mainly Features

- Can be operated from anywhere, no distance limitation;
- No call charges for inquiry. the GSM 3G Environment Alarm rejects the call from authorized number then return onsite temperature, humidity, and power voltage on the first 'ring';
- Multiple applications. (temperature, humidity, power status, solar panel, dc voltage);
- Up to 10 authorized phone numbers, 5 can be used to receive call or SMS,and 5 can be used to call and SMS while alarm occurrence;
- One Temperature & Humidity sensor input, measures temperatures from -40-80°C,0.5°C accuracy, Relative Humidity from 0-99RH%, accuracy is 3%;
- External AC Power status monitoring, AC On/OFF will send SMS to authorized phone numbers;



# GSM 3G Environment Alarm Temperature & Humidity & Power Status

- Inbuilt MCU monitoring the DC input Voltage value, measure range is 9-24VDC, no need additional sensor to save cost;
- Timer Report—Can setup every x hours automatically send its status/Value to the authorized numbers;
- Support remotely read historic data via SMS;
- Rechargeable Backup Battery inside can last 8hours;
- Secure - Using caller ID and password for identification, unknown callers are ignored;
- Programmable by SMS Commands or APPs with password protection;
- Based on GSM Network, applied to many applications.
- Remote Reset via SMS, Remote Reboot via SMS, Automatic Reboot Periodicity.

## 5. Physical Layout and Installation Diagram

### 5.1 Control Unit physical layout

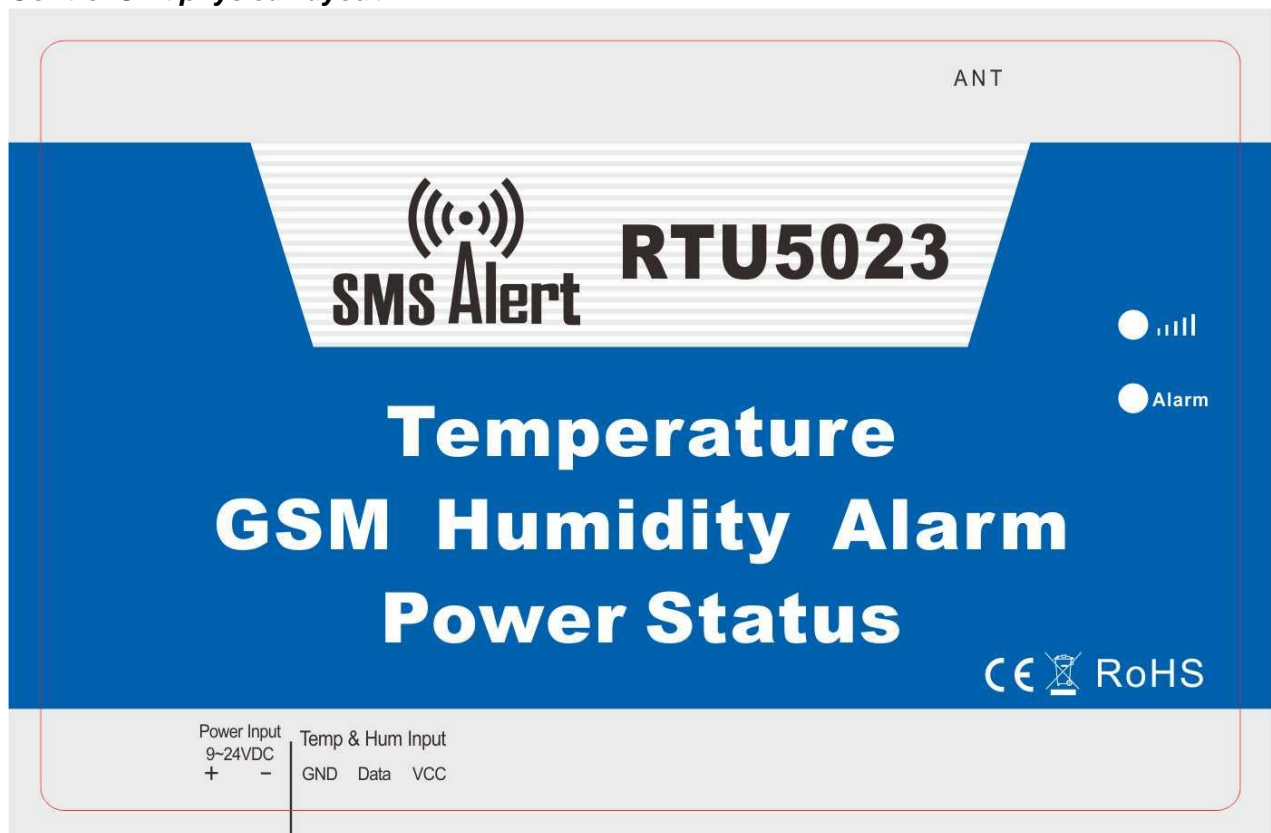

### LED Indicator Instruction

	GSM 3G indicator, registering Network flicks quickly, registered successful flicks slow.
	Alarm indicator, while alarm occurrence, will turn on.
<b>While alarm occurrence, the buzzer inside will make di sounds to alert.</b>	

### 5.2 Interface Instructions for installation

At the backside of the panel, please use the tool to remove the screw, and you can see the below:

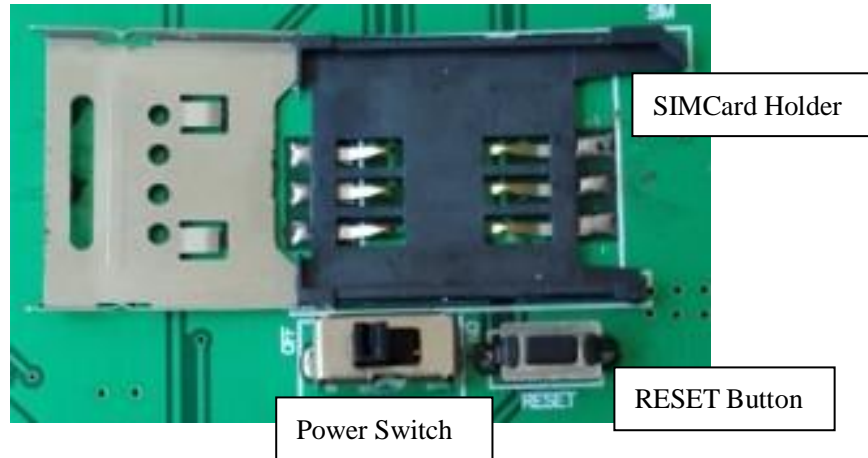

### 1) Insert SIMCard

Slide the SIM card holder in the direction of "OPEN" (etched on the SIM card holder), and then flip it open. Then Insert the SIM card with its gold contacts facing down and its cut-off corner facing out the SIM card slot. See below photo. Close the SIM card holder and then slide it in the opposite direction of "OPEN" to lock it. See above photo.

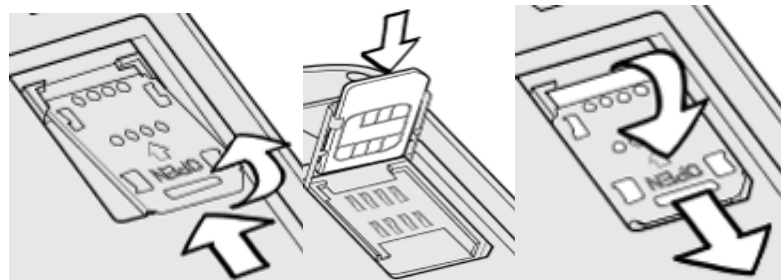

### 2) Connect External DC Power and Temperature & Humidity Sensor

See below interface, please contact the correct wires.

Connector Interface		
DC9~24V	+	DC9~24V positive input, 1A, for power on the GSM Unit.
	-	DC9~24V negative input, 1A, for power on the GSM Unit.
Temp&Hum Input	VDD	Connect to AM2301 Sensor VDD wire. Red wire.
	Data	AM2301 Data wire. Yellow wire.
	GND	AM2301 GND, black wire.



### AM2301 PIN Dfinition

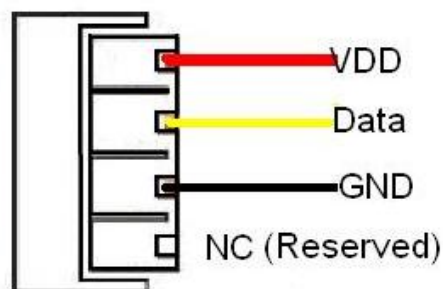

### 3) Monitoring AC Power Status or DC Status or DC Voltage

The RTU5023 will measure the input power DC9-24V voltage automatically, no need additional measure sensor to save cost and easy to installation.

- If you want to use the RTU5023 to monitoring 110/220VAC power status, then please connect a 9~24VDC@1A AC/DC adaptor to this 110/220VAC power directly. While AC/DC Power goes off, or goes on, will send SMS to alert you. Except need to setup the authorized user number to receive or inquiry Alarm message, and setup the voltage high alarm value as 9~24VDC, e.g.: if the AC/DC Adaptor is 9V or 24V, then should setup high alarm value as 9VDC or 24VDC. No need to setup any other parameters at all.

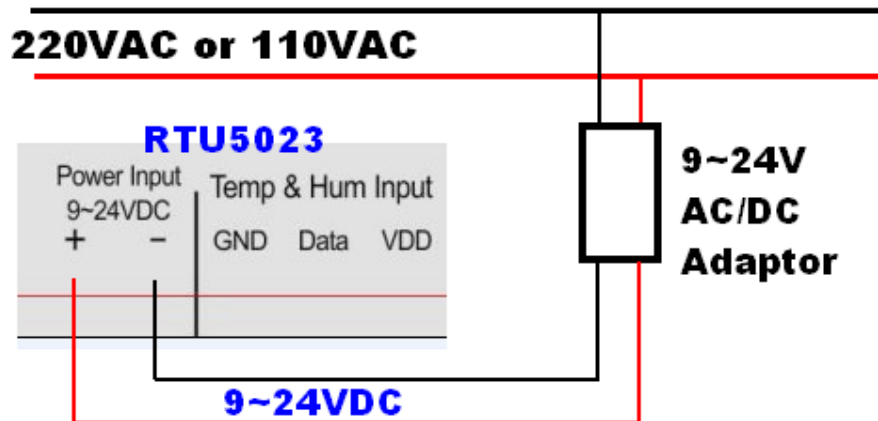

- If you want to use the RTU5023 to monitoring 9~24VDC power status or voltage, please connect the DC power to RTU5023 directly, for example, solar panel or battery or equipment status. And setup it is threshold value by SMS commands. See below. Connection:

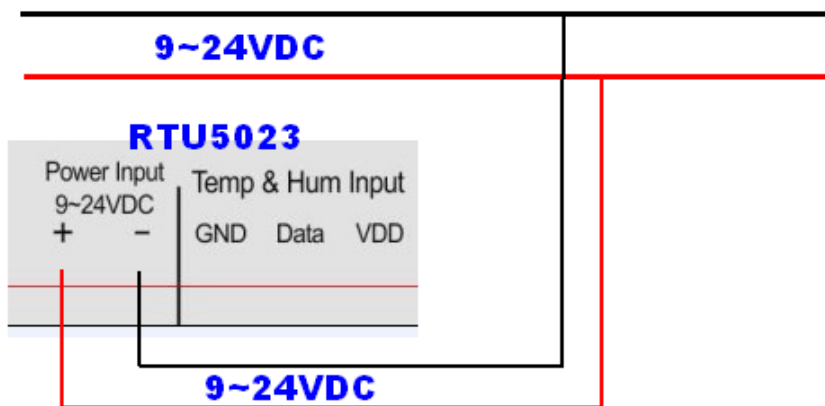

In this condition, the RTU5023 was powered on by the 9~24VDC directly

## 6. Initialize/Reset the GSM unit

The GSM/3G Unit can be reset to factory default once mistake programmed. please follow below steps to initialize it. After initialized, the parameters will set as factory default.

- 1) Switch off the GSM Unit
- 2) Press the RESET button;
- 3) Switch the Switch to ON side to powered on the GSM Unit, holding 10seconds, then loose the RESET Button.
- 4) Restart the GSM unit then will enter to work mode.



# GSM 3G Environment Alarm Temperature&Humidity&Power Status

## 7. Settings&Operation

**\*\*\*Strongly Recommend using the APP to program it\*\*\***

### Notice:

1. The default Password is **1234**.
2. The unit cannot support PIN Code Protected SIMCard.
3. You can program the GSM unit with SMS commands using your phone.
4. Remember that commands must be **CAPITAL LETTERS**. It is PWD not pwd, CAP not Cap etc. Don't add spaces or any other character.
5. The **pwd** in the commands is means the password, when you use it, please in stand of it by the digital number; the capital letters **PWD** is the command letter, use PWD directly.
6. In some GSM/3G operators they use different SMS parameter; the units can't return the SMS confirmation in some gsm operators, but it can performance the functions correctly. Also, you can try to add the country code before the number, see the below settings:

**For example:**

E.g.: the country code is **0086**, or **+86**.

The user cell phone number is **13600000000** and has been assigned as a SMS Alert number, the simcard number in the panel is **13512345678**.

When you setup the number as the authorized number, please setup as 008613600000000 or +86136000000000. Not 13600000000.

7. If the password is correct but the command is incorrect, the RTU5023 will return: **SMS Format Error, Please check Caps Lock in Command!** So please check the Command, or add the country code before the telephone number or check the input is in ENGLISH INPUT METHOD and CAPS LOCK. If password incorrect then will not any response SMS.
8. Once the GSM/3G Unit received the SMS Command, will return SMS to confirmation, if no SMS return, please check your command or resend again.
9. The SMS commands that you will certainly use in the GSM units are the following:

**\*\*SMS Commands For Program and Operation the RTU5023\*\***

### 1) Setup the RTU5023 SIMCard Number(Max 21 digits)

This number is used for automatically adjust the time from GSM Operator.

Command	Return SMS	Example
PWD+TEL+SIMCard Number+#	Set success!	1234TEL008613570810254#

### 2) Setup RTU5023 system Time

If you GSM/3G Operator cannot provide the time source then must setup the system time after power on. Otherwise, the RTU5023 will run it at mistake time. If you GSM Operator can provide time source, then no need to setup this time, but must setup the SIMCard number as 1) required.)

Command	Return SMS	Example
Setup PWD+Dyyyy-mm-dd+Thh:mm+#	xxxx(Y)XX(M)XX(D)xx(H)X(M)	1234D2015-05-22T12:58#
Inquiry PWD+D#T#	xxxx(Y)XX(M)XX(D)xx(H)X(M)	

### 3) Modify Password(4digits, Default is: 1234)

Command	Return SMS	Example
---------	------------	---------



# GSM 3G Environment Alarm Temperature & Humidity & Power Status

PWD+P+new password	[new password], This is the New Password, please remember it carefully.	<b>1234P4321</b> stands for change password from 1234 to 4321
--------------------	---	---

#### 4) Armed or Disarmed (After power on it is in Disarmed Mode)

Command		Return SMS	Example
Armed	PWD+AA	Armed	Armed stands for while alarm occurrence, should send SMS or dial to alert users,
Disarmed	PWD+BB	Disarmed	Disarmed stands for while alarm occurrence, will not send SMS or dial to alert users.)

#### 5) Setup Authorized User number (Total 10 authorized number, each number max 21 digits.)

- When alarm/Recovery occurrence, the RTU5023 will send predefined SMS to the 1st ~5th numbers, and send SMS also dial 6th ~10th numbers, till any one answer it or cycle dial 3 times.
- Just dial from Authorized User number, the RTU5023 will reject at the first "Ring", no communication cost, and then return the current temperature, humidity, power voltage by SMS.

Command		Return SMS	Example
Setup	PWD+A+Series Number + T + Telephone Number  (Series Number = 01~10, must be 2 digits)	1: --- 2: --- 3: 13570810254 4: --- 5: ---	<b>1234A03T008613570810254</b> to setup 008613570810254 as the 3 <sup>rd</sup> number.
Inquiry	PWD+A	Return All numbers	
Remove	PWD+A+Series Number	Return All numbers	<b>PWDA03</b> to remove the 3 <sup>rd</sup> number.

#### 6) Setup Temperature, Humidity, Voltage threshold Alarm Value and SMS Alert Text Message

- Temperature Unit: °C, Humidity Unit: RH%, Voltage Unit: VDC;
- Temperature and humidity ensure alarm/recovery time is 5seconds, voltage ensure alarm/recovery time is 2seconds. The ensure time means temperature, humidity, voltage exceed the pre-set value, and last for how many seconds then consider is an alarm event. This is in order to avoid false alarm.
- Default Threshold value are below:  
Temperature: High 80°C ,Low -40°C) ,  
Humidity: High 100RH%, Low 0RH%) ,  
Voltage: High 25VDC, Low 0VDC (=0 stands for external DC goes off)
- The users can definite the temperature, Humidity and voltage's SMS alert text message by SMS commands. After definition it, all of the alarm SMS will change to the definition text message. The SMS Alert Message max. 20 digits.
- When alarm occurrence, will send SMS to authorized user numbers, the SMS format is :  
**SMS Alert Message: [Current Value]+Unit, [Normal/Higher/Lower]**

In below commands, Series Number=1 stands for temperature; =2 stands for humidity, =3 stands for DC voltage.

Command		Return SMS	Example
Setup SMS Alert Message	PWD+AIN+Series Number+T+SMS Alert Message	Temp;xxxxx Humi:xxxxxx Volt:xxxxxxx	<b>1234AIN3TSolar Panel DC Voltage</b>
Inquiry	PWD+AIN+Series	Temp;xxxxx	<b>1234AIN123</b> to inquiry all





# GSM 3G Environment Alarm Temperature&Humidity&Power Status

	Number<nnn>	Humi:xxxxxx Volt:xxxxxxx	name, 1234AIN1 to inquiry temperature name.
Setup Temperature Threshold Value	PWD+AINR+1+Lxxx+H xxx# (The xxx must be 3digits, stands for real value x10, e.g. -5C must use -050, not -5. the xxx not supports decimal point)	Temperature: low:xxxC,High:xxxC.	<u>1234AINR1L-050H230#</u> to setup low value as -5C, and high value is 23C.
Setup Humidity Threshold Value	PWD+AINR+2+Lxxx+H xxx# (The xxx must be 3digits, stands for real value, e.g. 5RH% must use 005, not 5. the xxx not supports decimal point)	Humidity: Low: xxxRH%, High: xxxRH%.	<u>1234AINR2L005H098#</u> to setup low value as 5RH%, and high value is 98RH%.
Setup Voltage Threshold Value	PWD+AINR+3+Lxxx+H xxx# (The xxx must be 3digits, stands for real value x10, e.g. 0VDC must use 000, not 0, the xxx not supports decimal point)	Voltage: Low: xxxVDC, High: xxxVDC.	<u>1234AINR3L020H240#</u> to setup low value as 2V, and high value is 24V. <b>(If need to get the power failure alarm, then strongly recommend to set as this command.)</b>
Inquiry	PWD+AINR	TEMP: Low:xxxC,High:xxxC; HUMI: Low:xxxRH%,High:xxxRH%;. Volt:Low:xxxV,High:xxxV;	

## 7) Setup Daily Report Time(Default is 10:00AM)

The daily report is everyday report the RTU5023 current status by SMS to the 1st Authorized number.

Command		Return SMS	Example
Setup	PWD+DRT+Time	Daily SMS Report at:HH:MM	<u>1234DRT12:00</u> to setup daily report at 12:00AM
Inquiry	PWD+DRT	Daily SMS Report at:HH:MM	
Delete	PWD+DRTDEL	Daily SMS Report at:	<u>1234DRTDEL</u> stands for disable report.

## 8) Setup Interval Report Time

The interval report is interval to report the current status by SMS to the 1st Authorized number.

Command		Return SMS	Example
Setup	PWD+DTxxx (xxx=001-998hours, must be 3digits.)	Report status every xxx hour (S)	<u>1234DT003</u> to setup every 3 hours report by SMS.
Inquiry	PWD+DT	Report status every xxx hour (S)	
Delete	PWD+DT999	Report status every 999 hour (S)	Stands for disable report.

## 9) Inquiry Current Status(We recommend user inquiry it by call from authorized numbers)



# GSM 3G Environment Alarm Temperature&Humidity&Power Status

Command	Return SMS	Example
PWD+EE	Armed/Disarmed Temp:xxxxC,[Normal/Higher/Lower]; Humi:xxxxRH%,[Normal/Higher/Lower]; Volt:xxxxVDC,[Normal/Higher/Lower]; GSM Signal Value: IMEI: Version:	

## 10) Inquiry Historic Record (Only can inquiry the latest 100 alarm events.)

Command	Return SMS	Example
PWD+HIS+X  (X=1-100)	[IMEI Code as Device ID] 2015-07-15,18:18 1:[Current Value] °C,[Higher/Lower/Normal] 2015-07-15,18:18 2: [Current Value]RH%,[Higher/Lower/Normal] 2015-07-15,18:18 3: [Current Value]VDC,[Higher/Lower/Normal]  (1: Temperature, 2: Humidity, 3: Voltage. Each SMS will include one IMEI Code as Device ID.)	<b>PWDHIS5</b> to read the latest 5 historic record.

## 11) Remotely Reboot

Command	Return SMS	Example
Periodicity Reboot PWD++REBOOT+xxxx (xxxx=0-9999hours, 0 is disable, default is 160 hours)	Reboot: xxxxh (S)	<b>1234REBOOT3</b> The device will be reboot automatically for every 3 hours.
Inquiry PWD+RE	Reboot: xxxxh (S)	
Reboot Manually PWD+RT		

## 12) Remotely Reset

Command	Return SMS	Example
Remotely Reset PWD+RESET	Reset successfully	1234RESET

## 8. Technical specifications

Parameter item	Reference scope
DC Power supply	9~24VDC, recommend 12VDC1A
Power consumption	12V input Max. 50mA/Average30mA
Frequency range	2G :850/900/1800/1900Mhz 3G :W :900/2100Mhz C :850/1900Mhz T :850/2100Mhz
SIM Card	Supporting 3V SIM Card
GSM Antenna	50 Ω SMA Antenna interface
Temperature range	-40~+80 °C
Humidity range	Relative humidity 0~90% (condensation free)



# GSM 3G Environment Alarm Temperature&Humidity&Power Status

<b>Temp&amp;Humidity Sensor</b>	Temperature&Humidity Sensor, Model :AM2301 ,Temperatures from -40-80°C (0.5°C accuracy) ,Relative Humidity from 0-99RH%, accuracy is 3%.
<b>Backup Battery</b>	900mAH, last 8hours
<b>Exterior dimension</b>	W130mm*D74mm*H27mm
<b>Net Weight</b>	300 g

## 9. Warranty

- 1) This system is warranted to be free of defects in material and workmanship for one year.
- 2) This warranty does not extend to any defect, malfunction or failure caused by abuse or misuse by the Operating Instructions. In no event shall the manufacturer be liable for any alarm system altered by purchasers.

The End!

Any questions please help to contact us feel free.

[Http://www.GPRS-M2M.com](http://www.GPRS-M2M.com)